

CAD 4
 (FOR APP FIG. 1)
 "Y" OPTION USED
 ON TRUNK TEST SUPPLY FR

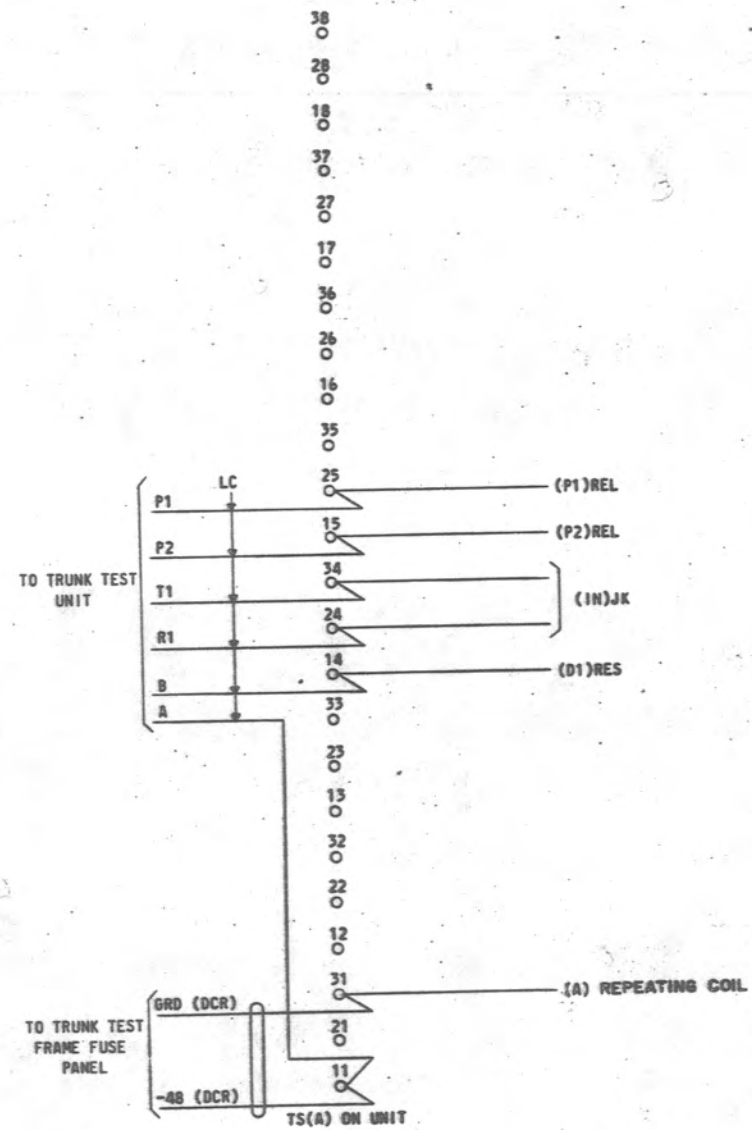

CAD 5
 (FOR APP FIG. 1)
 "Y" OPTION USED
 IN STEP BY STEP

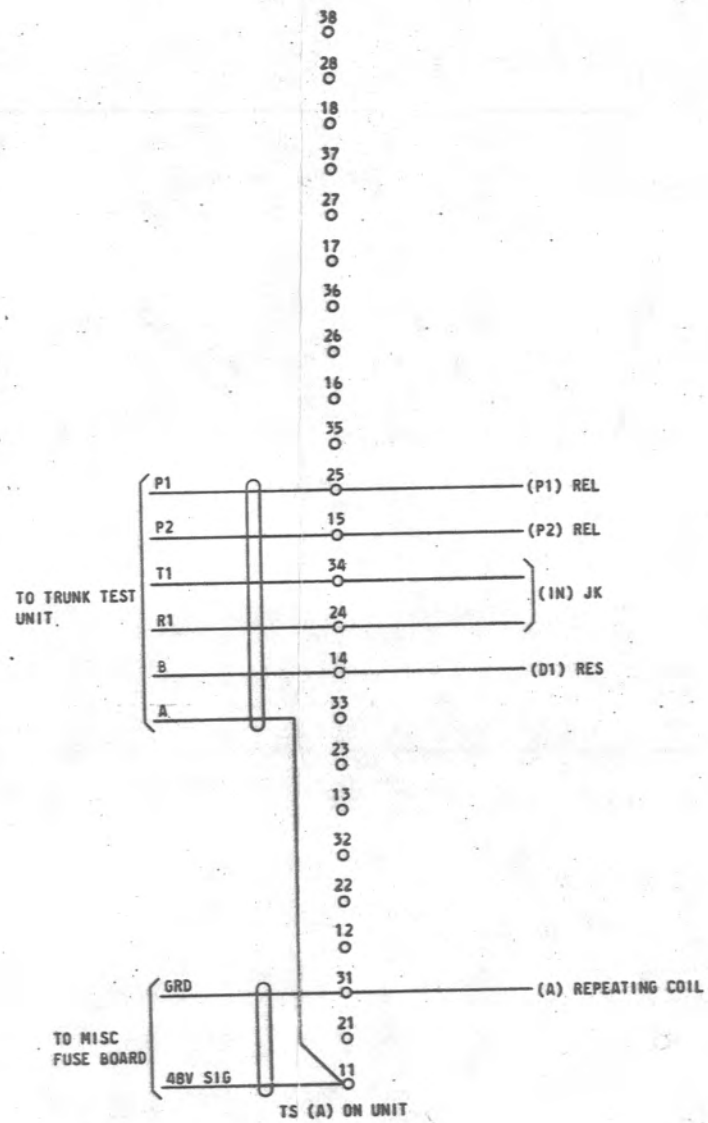

CAD 6
 (FOR APP FIG. 1)
 "Y" OPTION USED
 IN CONJUNCTION WITH
 NO. 4 OVERSEAS BRIDGED
 ACCESS TRUNK CIRCUIT

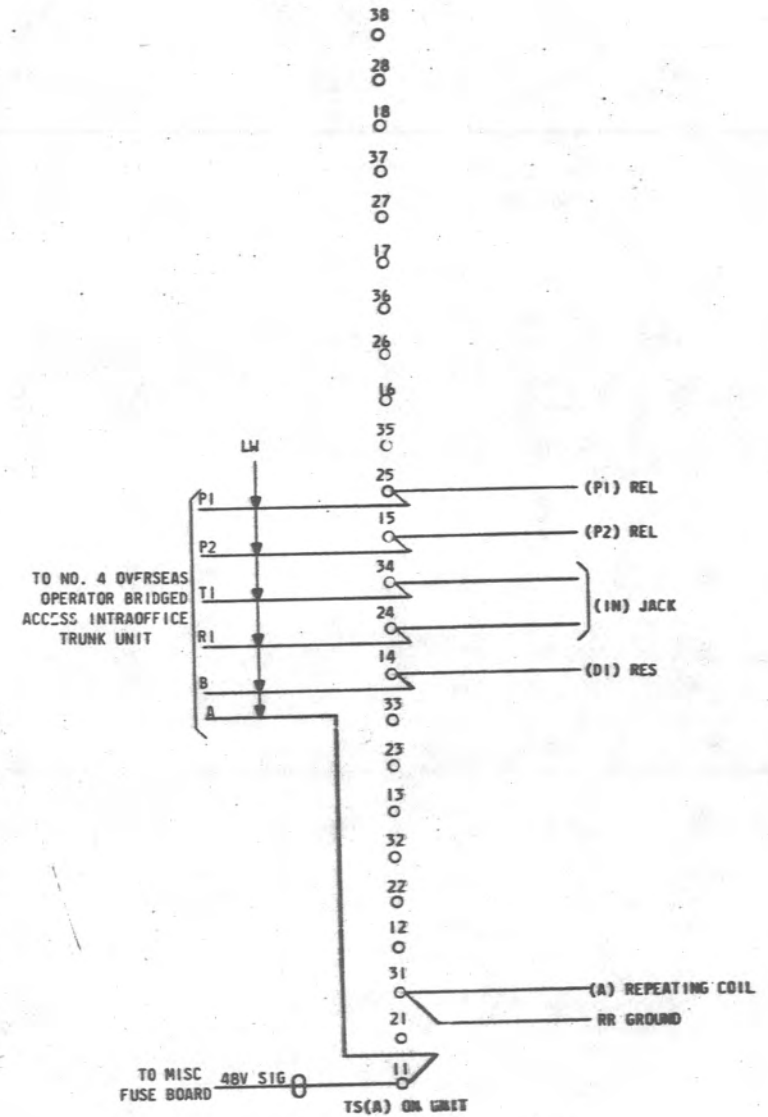

DRAWING	ISSUE
3D	REL
4D	REL
5D	REL
6D	REL

ISSUE
9B

DUAL CHANNEL RECEIVER CIRCUIT (2) SD-95956-01-4
 BELL TELEPHONE LABORATORIES 65

SD-95956-01-4

STABLO

CAD. 5
FOR FIG. 3

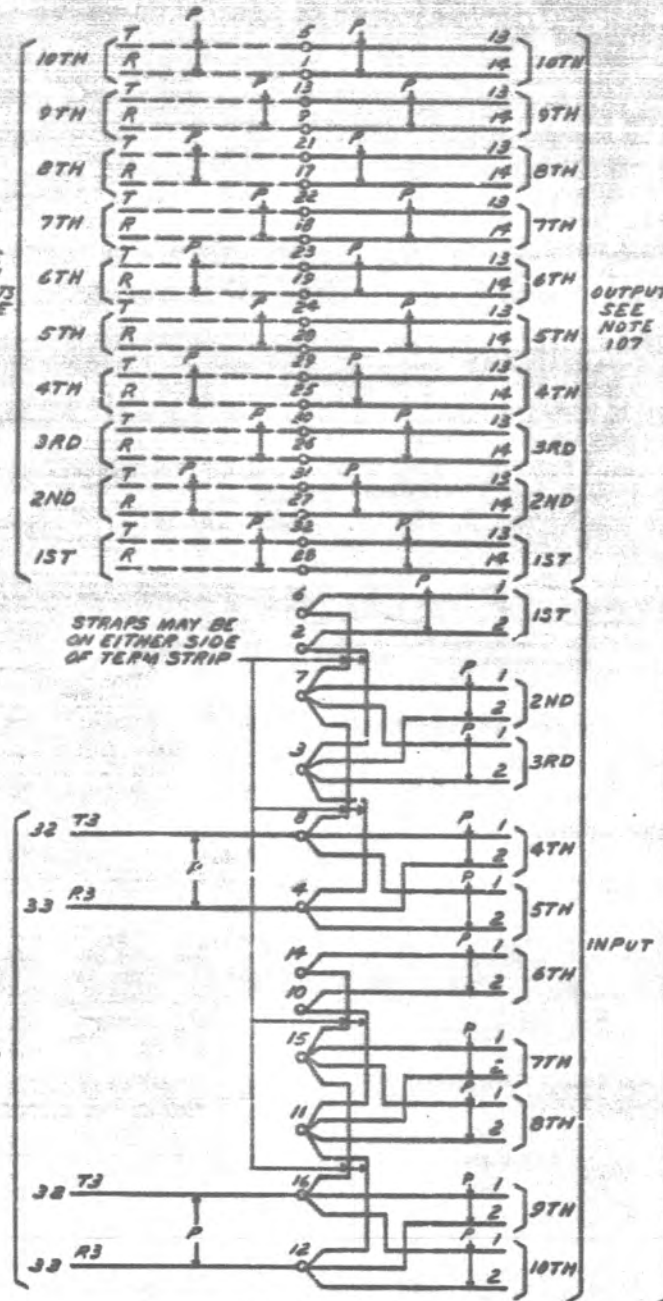

CAD. 6
FOR FIG. 3

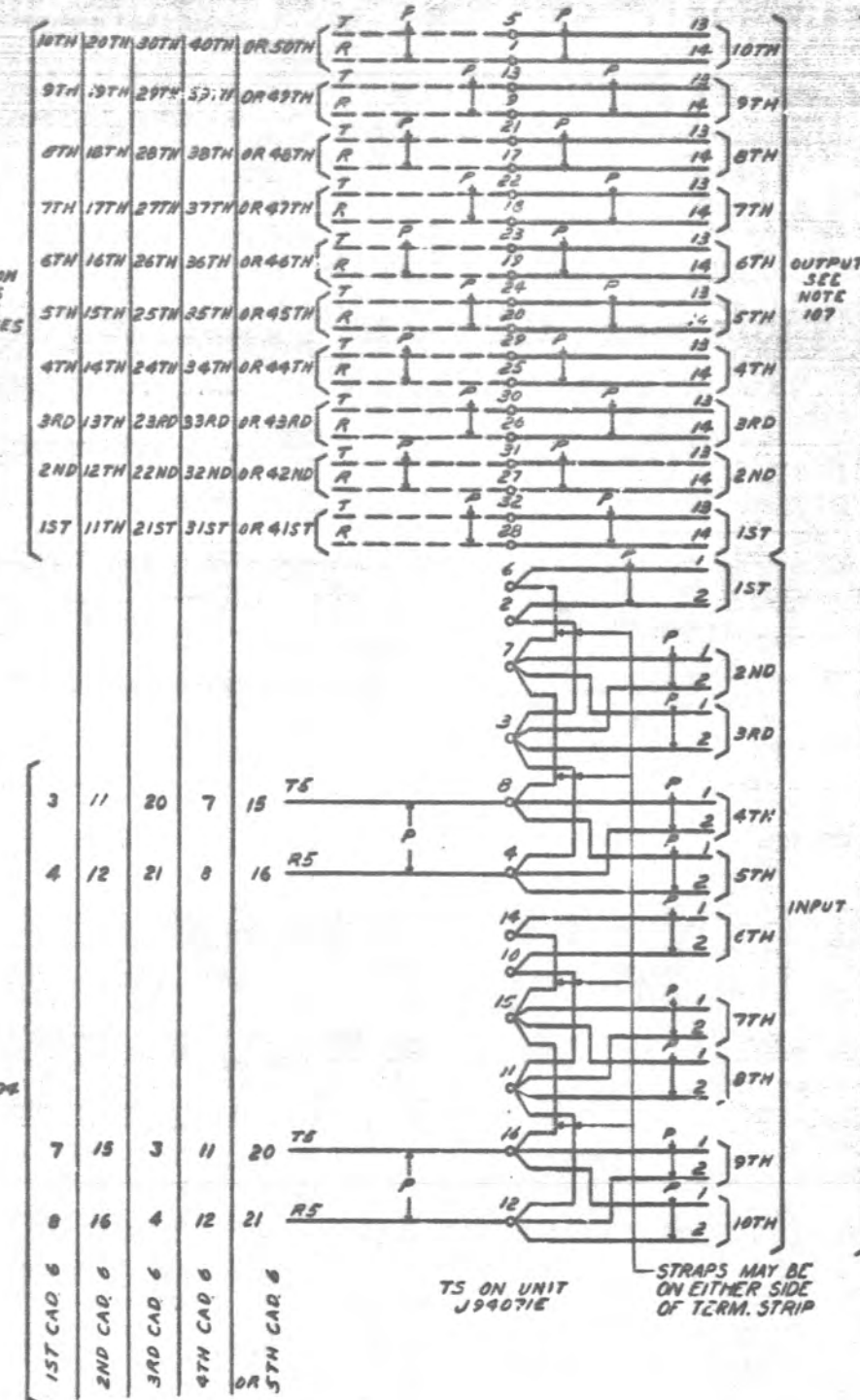

SD-95277-02-5

WILLIAMS DISTRIBUTING CKT
USING 71F WILLIAMS REFERENCE GENERATOR
BELL TELEPHONE LABORATORIES
INCORPORATED

SD-95277-02-5

65

ISSUE
7B

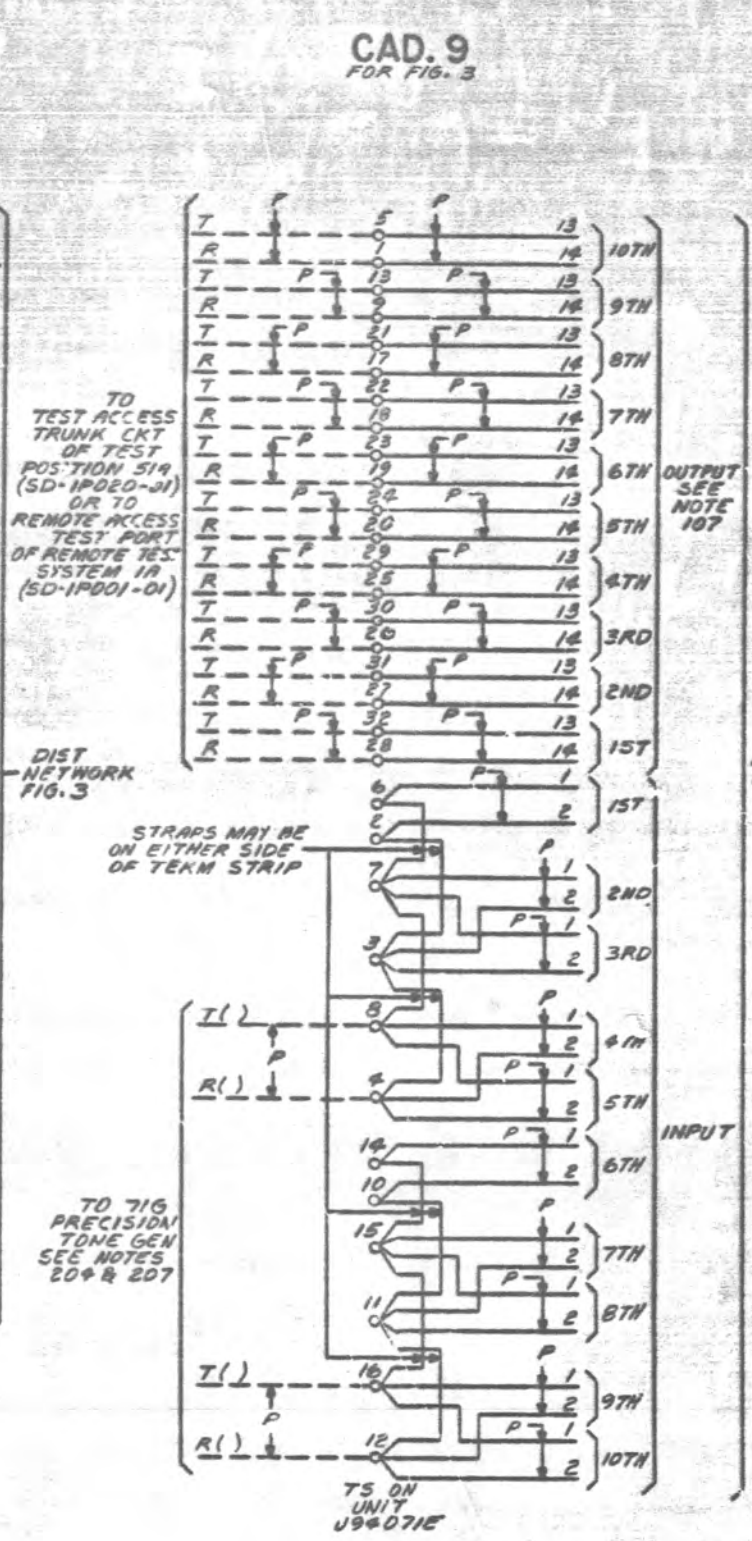
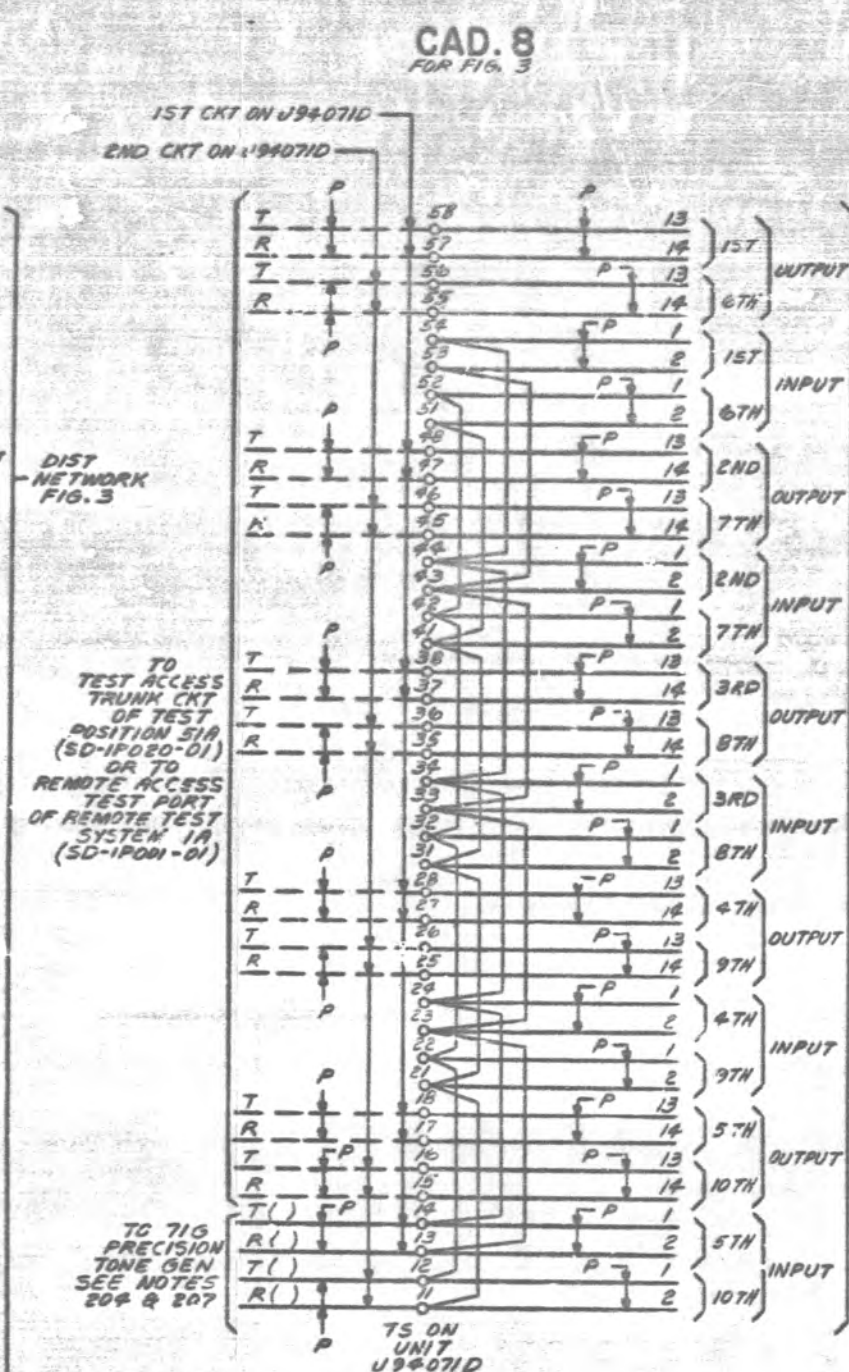
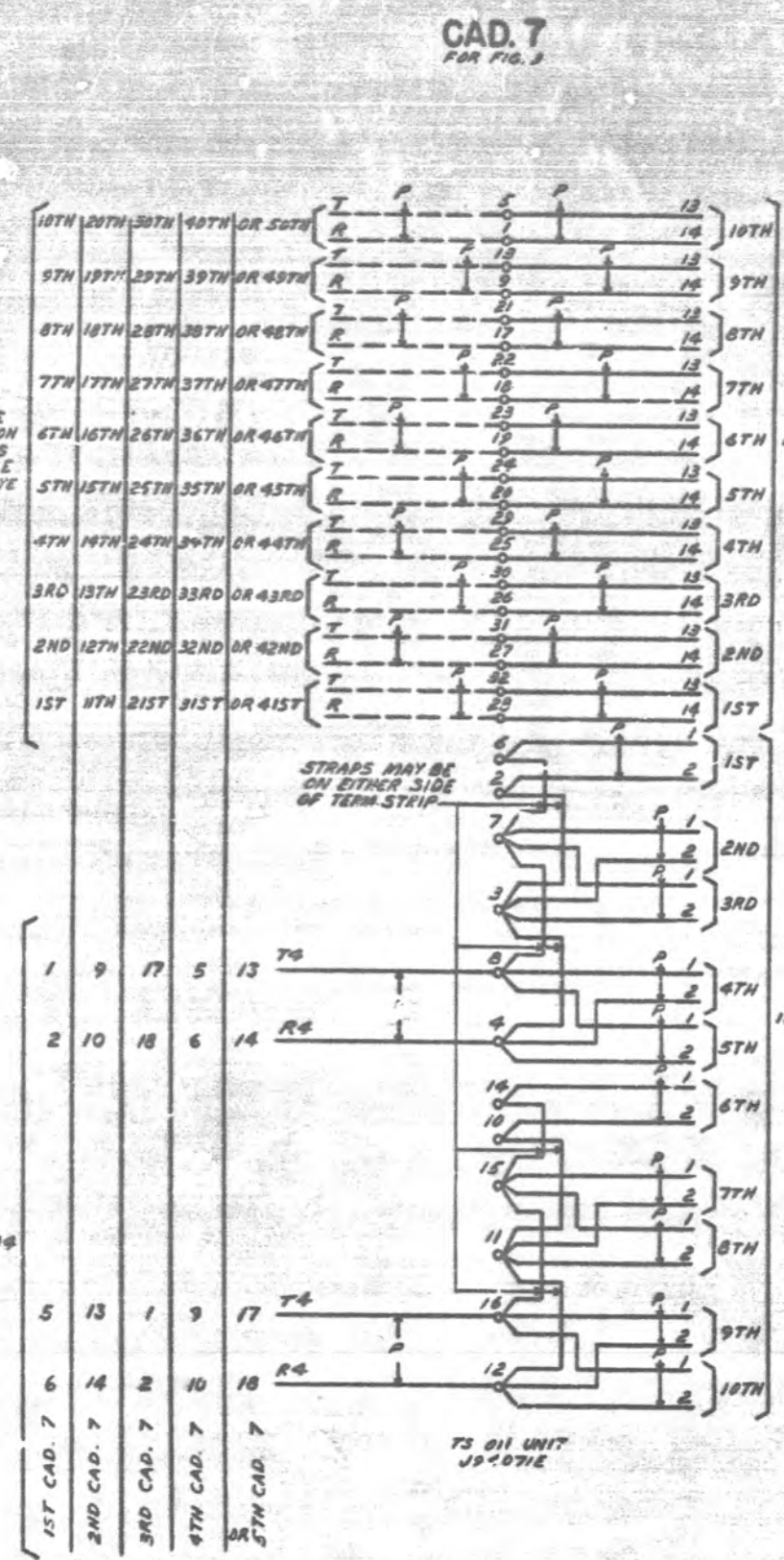

SD-95277-02-6