

SS-4 SELECTIVE SIGNALING SYSTEM GENERAL DESCRIPTIVE INFORMATION PRIVATE LINE TELEPHONE SERVICE

1. GENERAL

1.01 This section describes the SS-4 Selective Signaling System for 4-wire private line telephone service. SS-4 provides station-to-station signaling for multistation 4-wire systems.

1.02 This section is reissued to:

- Add TOUCH-TONE® dialing feature
- Add information on new J-1G033A2 SS-4 panel
- Add information on new RT19, RT20, and RT21 circuit packs
- Add information on new 18A card extender
- Rate the J-1G033A1 SS-4 panel and its RT1 circuit pack MD.

1.03 The SS-4 System (Fig. 1) is a modular panel arrangement designed for installation on customer premises. The only equipment required in the central office is a 4-wire bridge and associated amplifiers.

1.04 A modular 4-wire private line terminating panel, J-1G034A,L1 is used in the SS-4 System. This unit contains transmitting and receiving amplifiers to enable on-premise adjustment of incoming and outgoing transmission levels. A talk-back amplifier is included which permits on-premise conferencing. The terminating unit converts the 4-wire line to a low impedance buss connection which minimizes level variations caused by station sets being added or removed at each location.

1.05 One basic equipment arrangement is used in the SS-4 System. Optional features are

provided by means of option straps on the various circuit packs used in the modular panels, by the type circuit pack used or through interfaces to external equipment.♦

1.06 The SS-4 System is compatible with and can be used in the same 4-wire private line telephone system with the SS-1 (SD-98093-01) and the SS-1A (SD-69594-01) equipment.

1.07 Interarea switching circuits cannot be connected to the SS-4 equipment. However, the SS-4 System can be added to an existing 4-wire private line arranged for interarea switching.

1.08 The 3- and 4-type speakerphones can be used with the SS-4 System.

1.09 The 106-type loudspeakers are compatible with the SS-4 System and can be activated or deactivated to meet customer needs.

1.10 ♦Rotary dial, TOUCH-TONE dial, or both type telephone sets, may be used with the SS-4 System. Where the TOUCH-TONE feature is used, the J-1G033A2 SS-4 panel and its associated circuit packs must be used.♦

1.11 The SS-4 System can be used with the No. 300 Switching System. Locally-wired options are required to adapt the SS-4 equipment for use with the No. 300 Switching System.

1.12 Data service can be provided with the SS-4 System. A data transfer circuit must be provided locally to transfer the transmission leads to the data equipment. The SS-4 System must be arranged for privacy to avoid interruptions during data transmissions.

NOTICE

Not for use or disclosure outside the
Bell System except under written agreement

2. FEATURES

2.01 Features of the SS-4 System.

- Provides 4-wire private line signaling with provision for dialing 81 separate and distinct 2-digit codes.
- Provides the required time to change the guard mode of some single frequency signaling units by lengthening the first pulse of each digit dialed.
- Establishes a time base in a pulse counting and digit register, during which the second digit shall be dialed.
- Restores the counting circuit to normal following the second digit registration.
- Restores the counting circuit to normal if receipt of the second digit has not been received within 6 seconds.
- Transmits busy tone to all stations during the dialing interval.
- Provides a means for restoring the circuit to normal when the digit 1 is dialed (to cancel an erroneously dialed first digit).
- Signals any one of 81 stations by dialing two digits without the operation of supplementary keys.
- Provides an oscillator circuit which generates 2600-, 2400-, or 2170-Hz signals and busy tone.
- Provides variable adjustment of the oscillator frequency and level.
- Has jack appearances to facilitate lineup and testing.
- Provides a means for opening the transmission leads to station set transmitters during signaling to exclude noise.
- Provides a means for stations to signal and conference with other stations at the same customer location.

- Has a system wide exclusion (privacy) as an optional means for locking out all stations from a conversation, with the exception of the called and originating stations. Exclusion is initiated by automatic or manual control features.
- Releases privacy automatically upon termination of a call.
- Provides optional override privacy exclusion at selected stations equipped with an override key and sends warning tone to alert the parties conversing that they are being overridden.
- Has optional ability at selected stations to enter a privacy conversation to request that the line be released and to apply a warning tone during use of this feature.
- Operates from a 24-volt power supply.

3. METHOD OF OPERATION

3.01 Two-digit dialing is required for each of the 81 possible codes. The digit 1 is not assigned in any combination of the 81 station codes. The system is ready for dialing when the handset is removed from the switchhook, unless another station has control of the system. Depending on the option used, circuit availability can be observed via a busy lamp or by momentarily monitoring with the handset before dialing.

3.02 ♦Rotary♦ dial pulses are converted to 2600- and 2400-Hz frequency shift pulses by the keyer circuit for transmission over the 4-wire line facility. ♦TOUCH-TONE frequencies are converted to binary-coded decimal pulses which in turn are converted to dial pulses to pulse the keyer.♦ No tones are on the line during an idle condition. The frequency shift tone pulses are reconverted to dc dial pulses by a single frequency receiver at each distant location on the private line.

3.03 Upon receipt of the first pulse of any code, the SS-4 System applies tone as a busy signal indication to all telephone receivers until the second digit has been dialed or until the end of the 6-second time-out period when a call is abandoned. The second digit must be dialed within 6 seconds of the last pulse of the first digit or the calling station is released. Signaling the called

station is accomplished by a dc ground pulse of 0.1-second duration to operate the signaling circuit pack associated with the code output lead. Conference calls are accomplished by sequentially dialing as many 2-digit station codes as desired.

3.04 If an erroneous first digit has been dialed, it may be cancelled by dialing the digit 1. This eliminates the 6-second waiting period required for the first digit registers to release.

3.05 Two optional privacy arrangements are available in the SS-4 System. Option Y provides automatic privacy. Option X requires the operation of a key. Automatic privacy arrangement excludes all stations except the calling and called station no matter which station makes a call. The busy tone is sent to all stations, other than the called station, and these stations remain locked out until the call is terminated. Option X is a selective type privacy arrangement which limits the privacy feature to those sets equipped with an exclusion key. Operation of this key will lock out all stations except the called and calling station. With either option, additional stations may be dialed into a privacy call by the originating station or by one of the called stations at each distant location. Dialing control at any called location is seized by that station when a rotary dial is first moved off-normal or a TOUCH-TONE button is operated. Add-on stations at the called locations cannot dial additional stations.

3.06 Privacy is terminated when the last station at the originating location goes on-hook. The other stations may continue talking without privacy, or one of them may elect to initiate a new call to reestablish privacy.

3.07 Privacy override may be accomplished at any station equipped with an override key. The operation of this key releases all the locked out stations in the entire system. When this feature is activated, a tone is placed on the system as a signal of the intrusion.

3.08 Local override of privacy at selected stations permits intrusion into an existing conversation without the release of privacy. Operation of the local override key at a station applies a steady intrusion tone to the system to indicate to the parties the circuit should be released for urgent use by that station.

3.09 Alternate data service requires the use of a data transfer circuit. The locally-provided transfer circuit is arranged to transfer the 4-wire line from the SS-4 telephone set(s) to the data set, to attenuate line levels to and from the data set, to provide a loopback circuit to the data set (where required), to light a transfer lamp, to light the line lamp on a key telephone set(s), and to hold privacy in the SS-4 equipment.

3.10 The SS-4 Selective Signaling System can be used with the No. 300 Switching System at air route traffic control centers of the FAA. Dialing is accomplished in a slightly different manner when the No. 300 Switching System is involved. Before dialing, the station operator seizes a 300 system register sender by operating the line pickup key associated with SS-4. Two digits, the desired station code, are key pulsed into the register sender. The register outpulses the digit 1, sends the two station digits inserted by the station operator, then drops off the line. Since the register sender drops off the line automatically as soon as the station code is outpulsed, it must be repeatedly resealed if a number of station codes are to be outpulsed in succession.

3.11 If a dialing error is made on the first digit, it may be corrected by pressing the CLEAR key on the No. 300 Switching System. By this action, the sender is cleared but not released. The correct code may then be key pulsed into the sender without the necessity of reseizing the sender.

3.12 The digit 1, which precedes the station code when the sender outpulses, clears the decoders at all other locations. If the digit 1 were to be keyed to cancel an error when using the No. 300 Switching System, the sender would release. It would be necessary to reseat the sender before the station code could be sent correctly.

4. COMPONENTS

4.01 The SS-4 equipment is comprised of one J-1G033A1,L1 (MD) modular panel (Fig. 2), or one J-1G033A2,L1 modular panel (Fig. 3) together with one or more J-1G034A1,L1 modular panel(s) (Fig. 4), and associated plug-in circuit packs (CPs).

CIRCUIT PACKS—J-1G033A1,L1 (MD) PANEL ONLY

A. -5 Volt Regulator Circuit—RT1 CP (MD)

4.02 Located on the back plane of the J-1G033A1 panel and hardwired into circuit, it provides all -5 volt power for the panel.

CIRCUIT PACKS—J-1G033A1,L1 (MD) PANEL OR J-1G033A2,L1 PANEL

A. 2600-Hz Detector Circuit—RT2 CP

4.03 Located in the receive side of the transmission path, the 2600-Hz detector circuit:

- Provides impedance matching and isolation between the line and the SS-4 equipment
- Blocks the 2600-Hz tone signal
- Converts energy from the incoming 2600-Hz tone signals to *on* and *off* signals for dial pulsing, for activating privacy modes, and for disconnect signals.

B. Oscillator Control Circuit—RT3 CP

4.04 The oscillator control circuit contains an oscillator circuit, an oscillator driving circuit, and level pads. Local dial pulsing activates the driving circuit and causes the oscillator to send 2400- and 2600-Hz frequency shift signals to distant locations. A low busy tone of 2600 Hz is provided by the oscillator when the privacy feature is used or when a station goes off-hook after another station has started dialing. The oscillator control circuit also provides a low level 2170-Hz tone on the line when an intrusion is made to request release of the system.

C. Keyer Circuit—RT4 CP

4.05 The keyer circuit accepts several types of information from local stations and contains the logic which converts this information into signals that are then transmitted to the oscillator control circuit (RT3 CP). Signals from the keyer circuit drive the oscillator control circuit. The keyer circuit also provides a privacy release signal when the privacy originating station goes on-hook.

D. Dial Pulse and Privacy Detector Circuit—RT5 CP

4.06 Signals from distant stations or dial pulses from local stations activate the dial pulse and privacy detector circuit which repeats and forwards the information to the pulse counter decoder circuit (RT6 CP). Privacy signals are detected and timed, and a locking path is established by the dial pulse and privacy detector circuit. The way station lockout feature disables the pulse counter circuit so that dialed digits are not decoded at locked-out systems.

E. Pulse Counter Decoder Circuit—RT6 CP

4.07 The pulse counter decoder circuit registers the number of pulses by the 2600-Hz detector circuit (RT2 CP) or the dial pulses generated by a local station. It converts the registered pulses to ground signals and connects them to the C lead selector circuit (RT8 CP) over the tens and units leads. In addition, it enables the RT5 and RT4 CPs to send the 2600-Hz privacy set signal to distant locations.

F. Common Control Circuit—RT7 CP

4.08 The common control circuit provides a locking ground for privacy, stores disconnect signals, and applies low 2600-Hz busy tone to indicate that the system is in the privacy mode or that another station is off-hook and is in the process of dialing. When the location has a system override key, operation of the key operates the system override relay in the common control circuit to start privacy release.

G. Code Lead (C Lead) Selector Circuit—RT8 CP

4.09 The code lead selector circuit receives ground signals over the tens and units leads from the pulse counter decoder circuit (RT6 CP) and converts these signals to a single 100-ms ground signal which is connected to a dialed code (C) lead.

CIRCUIT PACKS—J-1G033A2 PANEL ONLY

A. Binary to Dial Pulse Converter—RT19 CP

4.10 Circuit pack RT19 converts binary-coded decimal pulses to rotary dial pulses that are used to pulse the keyer for outgoing signals. Used for the TOUCH-TONE option only.

B. TOUCH-TONE Converter—RT20 CP

4.11 Circuit pack RT20 receives local TOUCH-TONE signals and converts them to binary-coded decimal pulses. Used for the TOUCH-TONE option only.

C. -5 Volt Regulator Circuit—RT21 CP

4.12 RT21 is a plug-in circuit pack that provides all the -5 volt power for the J-1G033A2 panel. It also provides a -24 volt filter for the panel.♦

CIRCUIT PACKS—J-1G034A1,L1 PANEL ONLY**A. Option Card—RT9 CP**

4.13 Option card RT9 is a printed wiring card that provides the panel options for all modes of circuit operations. The card plugs into a connector on the back of the panel.

B. Line Amplifier—RT10 CP

4.14 The line amplifier provides the required gain to maintain transmission levels and has an equalizer circuit for line equalization. The line amplifier has a test that will accommodate a 310 plug.

C. Talk-Back Amplifier—RT11 CP

4.15 This circuit pack uses step-down transformers to convert the 600-ohm line to a low impedance talk buss. The transmit buss is coupled through a sidetone amplifier circuit to the receive buss to provide sidetone. Transmit and receive jacks, J1 and J2, are provided to send and receive test tones for circuit lineup tests.

D. Station Circuit—RT12 CP

4.16 The station circuit is associated with one telephone set. The station circuit furnishes talk battery to the telephone set, provides line pickup and cut-through, opens the talk path to the telephone set when a push-to-talk handset is

used, pulses the dial leads from a rotary dial telephone to the SS-4 panel, and releases the locked-in signal from a signaling circuit.

E. Audible and Visual Signaling Circuits—RT13 CP and RT14 CP

4.17 The audible and visual signaling circuits are activated by a 100-ms ground signal from the code lead. They furnish audible and visual signals to the telephone set(s). The RT13 CP contains three separate audible and visual signaling circuits. The RT14 CP contains one audible and visual signaling circuit and one group code circuit. The group code circuit is used to connect a single code lead to a maximum of six audible and visual signaling circuits.

5. POWER REQUIREMENTS

5.01 A -24 volt power source is required for the SS-4 circuitry. When lamps are provided, a 10-volt power supply will be required. Ringing requires a 105-volt power source.

5.02 One 19- or 20-type power supply will power the J-1G033A1 panel and one J-1G034A1,L1 panel. Each additional J-1G034A1,L1 panel requires an additional 19- or 20-type power supply.

6. MAINTENANCE

6.01 The circuit packs may be checked by substitution with a replacement known to be in working order. Jacks are available on the line amplifiers (RT10 CPs) and talk-back amplifier (RT11 CP) for circuit lineup. Other maintenance checks are limited to normal telephone checks and inspection of connecting block wiring and station cables.

6.02 ♦The 18A extender is available from Western Electric. This extender is provided as a maintenance and troubleshooting tool for use between the circuit packs and associated connectors.♦

6.03 Refer to Section 480-632-002 for detailed maintenance of the SS-4 System.

SECTION 982-329-100

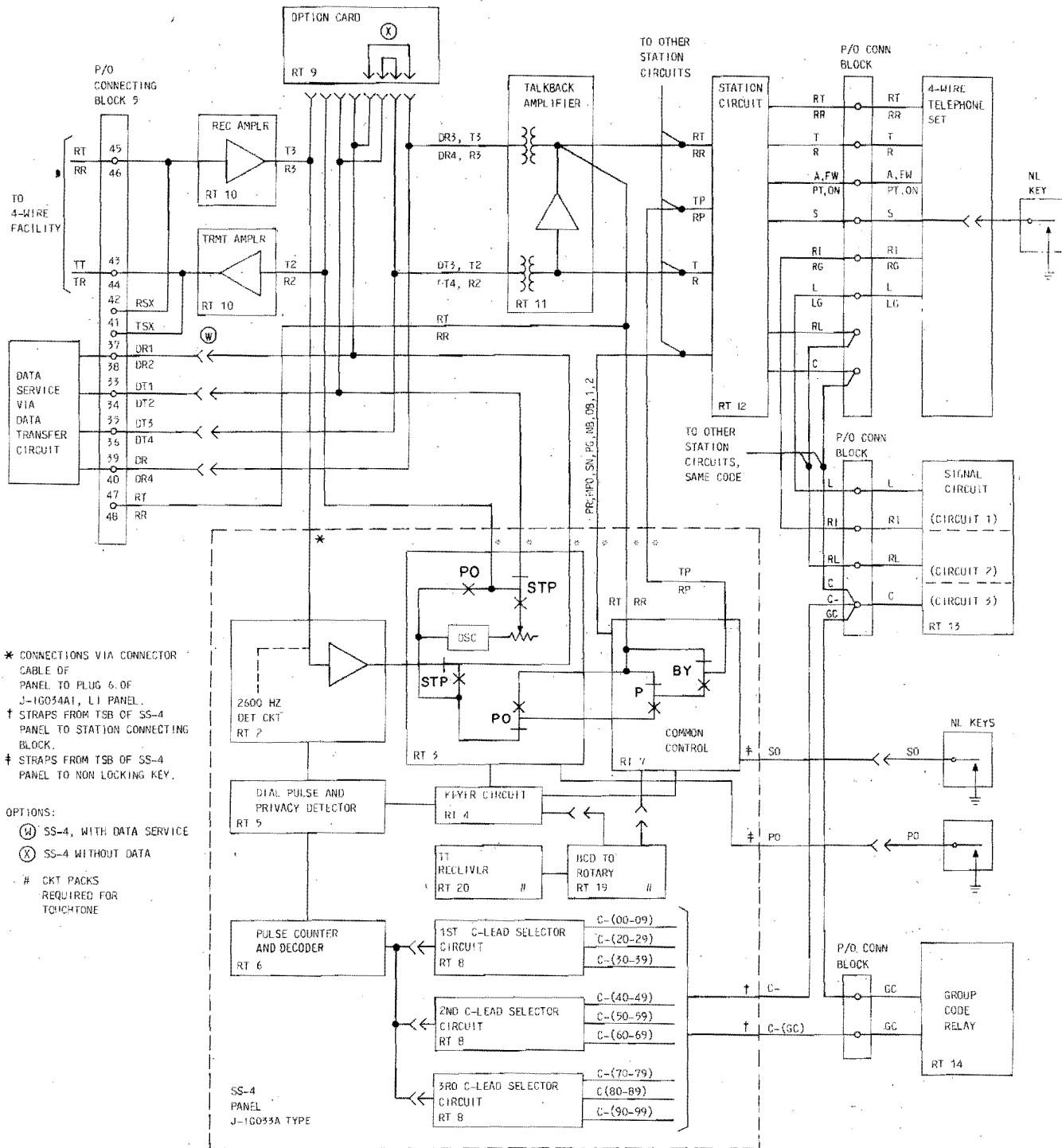

* CONNECTIONS VIA CONNECTOR CABLE OF PANEL TO PLUG 6 OF J-1G034A1, L1 PANEL.
 † STRAPS FROM TSB OF SS-4 PANEL TO STATION CONNECTING BLOCK.
 ‡ STRAPS FROM TSB OF SS-4 PANEL TO NON LOCKING KEY.

OPTIONS:
 (W) SS-4, WITH DATA SERVICE
 (X) SS-4 WITHOUT DATA

CKT PACKS REQUIRED FOR TOUCHTONE

Fig. 1—SS-4 Arrangement

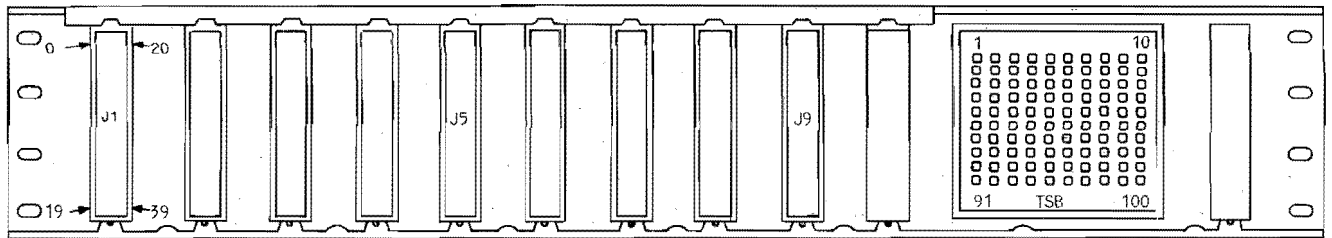

FRONT VIEW J-1G033A1 (MD) PANEL (SD-1G296-01)

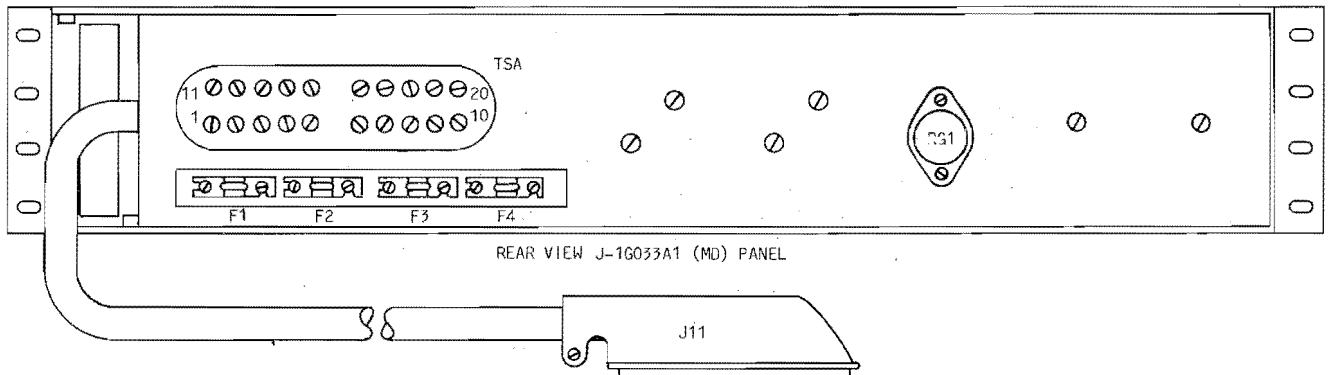

REAR VIEW J-1G033A1 (MD) PANEL

NOTES:

1. THE J-1G033A1, (MD) PANEL MOUNTS IN A 23-INCH BY 4-INCH MOUNTING SPACE.
2. POWER CONNECTIONS ARE MADE ON TERMINAL STRIP A.
3. CODE LEADS AND MISCELLANEOUS LEADS ARE CONNECTED TO TERMINAL STRIP B.
4. CONNECTORS, J1 THROUGH J9, ACCOMMODATE THE PLUG-IN CIRCUIT PACKS THAT COMPRISE THE SS4 CIRCUITRY.
5. THE 24-INCH CONNECTOR ENDED, CONNECTOR CABLE CONNECTS TO PLUG 6 OF AN ASSOCIATED J-1G034A1,L1 4-WIRE PRIVATE LINE TERMINATING CIRCUIT.

Fig. 2—J-1G033A1,L1 (MD) Panel

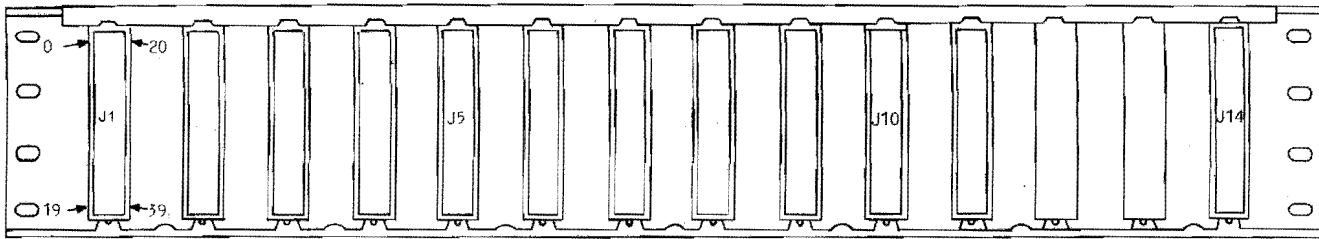

FRONT VIEW J1G033A2 PANEL (SD 1G296-01)

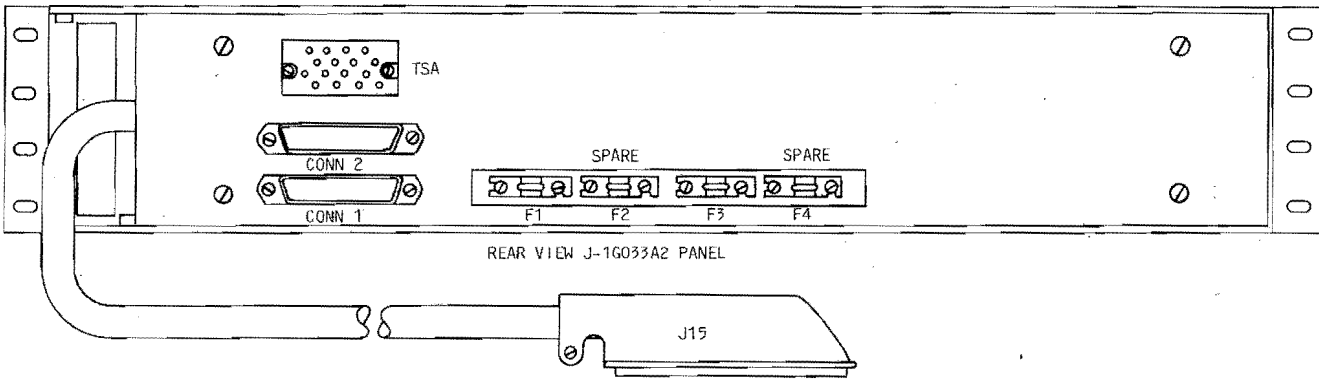

REAR VIEW J-1G033A2 PANEL

NOTES:

1. THE J-1G033A2 PANEL MOUNTS IN A 23-INCH BY 4-INCH MOUNTING SPACE.
2. POWER CONNECTIONS ARE MADE ON TERMINAL STRIP A.
3. CODE LEADS AND MISCELLANEOUS LEADS ARE CONNECTED TO CONNECTORS 1 AND 2 WHICH SHOULD BE TERMINATED ON 66 TYPE BLOCKS WITH A 25B CONNECTOR CABLES.
4. CONNECTORS, J1-J11 AND J14, ACCOMMODATE THE PLUG-IN CIRCUIT PACKS THAT COMPRISE THE SS4 CIRCUITY.
5. THE 24-INCH CONNECTOR ENDED, CONNECTOR CABLE CONNECTS TO PLUG 6 OF AN ASSOCIATED J1G034A1,L1 4-WIRE PRIVATE LINE TERMINATING CIRCUIT.

Fig. 3—J-1G033A2 SS-4 Panel

100002

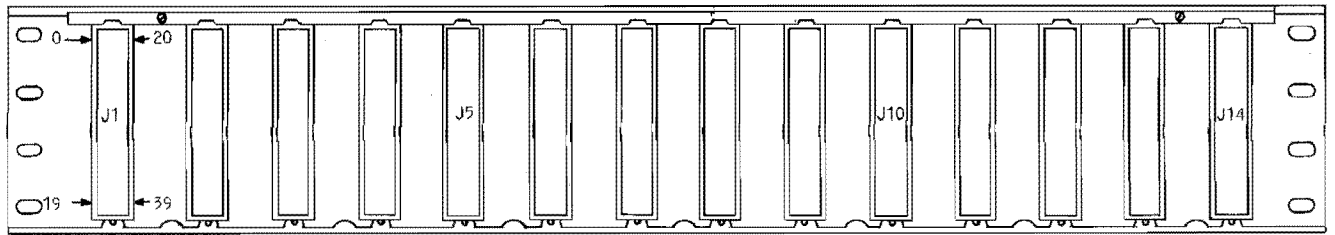

FRONT VIEW J-1G034A1 PANEL (SD-1G297-01)

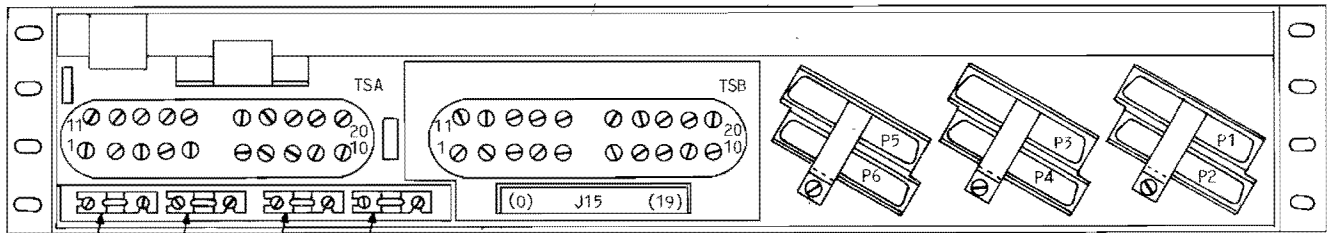

REAR VIEW J-1G034A1 PANEL

NOTES:

1. THE J-1G034A1, L1 PANEL MOUNTS IN A 23-INCH BY 4-INCH MOUNTING SPACE.
2. POWER CONNECTIONS AND INTERRUPTER LEAD CONNECTIONS ARE MADE ON TERMINAL STRIP A.
3. CONNECTIONS TO SUCCEEDING OR PRECEDING PANELS ARE MADE ON TERMINAL STRIP B.
4. PLUGS 1 THROUGH 5 ACCOMMODATE CONNECTOR CABLES TO STATION CONNECTING BLOCKS.
5. PLUG 6 ACCOMMODATE THE CONNECTOR CABLE FROM A SS4 PANEL (J-1G033A1(MD) OR J1G033A2).
6. CONNECTORS, J1 THROUGH J14, ACCOMMODATE THE PLUG-IN CIRCUIT PACKS FOR STATION FUNCTIONS.
7. CONNECTOR J15 (ON REAR OF PANEL) IS USED ONLY FOR THE RT 9 OPTION CARD.

Fig. 4—J-1G034A1,L1 Panel